

GST-60-16

60" Salad/Sandwich Prep Table

The Glacier sandwich/salad prep tables are crafted from durable brushed stainless steel, guaranteeing longevity and easy upkeep. These units cool from underneath the pan lip, bypassing the necessity for an air curtain, an innovative design to prevent product dry out. A solid stainless steel sheet beneath the pans acts as a barrier, preventing food from falling into the cavity of the unit. It comes with 1/6 pan containers for versatile food storage. Its sleek design includes recessed handles for comfort and easy cleaning. Foam insulation ensures proper cooling, while self-closing doors and auto-defrosting functionality contribute to energy efficiency and sustained cold temperatures.



Features

- Insulated cover
- Refrigerates from under pan lip
- Recessed door handle
- Comes complete with 1/6 pans
- 2 epoxy-coated removable shelves
- 5" casters with locks on front
- 2-year parts and labour warranty
- 5-year compressor warranty

Technical Specifications

- Stainless steel exterior finish
- Stainless steel interior finish
- 115 V/60 Hz
- R290 refrigerant
- Automatic defrost

Optional Features/Accessories

- 3" and 4" casters available for purchase

GST-60-16

60" Salad/Sandwich Prep Table

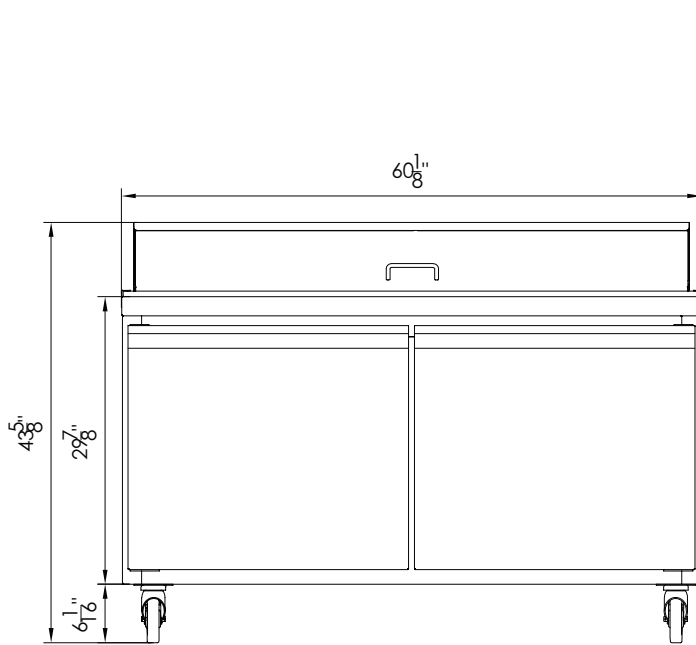

FRONT

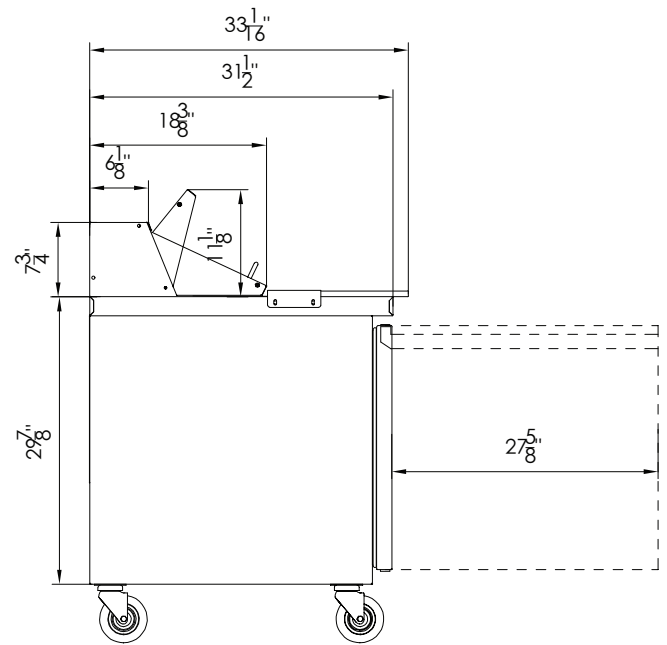

LEFT

GST-60-16: 16x1/6 PAN
REGULAR TOP



Model	External Dimensions (inches)			Crated Dimensions (inches)			Temperature Range °F	Cutting Board Size WxD (inches)	Compressor Power (HP)	Net Weight	Gross Weight	# of Shelves	NEMA Config.	Amps
	W	D	H	W	D	H								
GST-60-16	60 1/8	33 1/16	43 5/8	64 3/8	35 7/8	48 3/8	33 ~ 41°F	60 x 14.5	1/5	275	380	2	5-15P	2.4

Specifications are subject to change without notice.