

GCB-36

36" Refrigerated Chef Base

The Glacier chef base supports heavy duty cooking equipment with its sturdy stainless steel top and adjustable corner edges to keep equipment in place. Recessed drawer handles allow for easy opening. Each drawer has dense foam and gaskets to effectively retain cold air. A large, self-lubricating evaporator fan ensures consistent airflow throughout the cabinet, maintaining optimal temperatures for food storage. Temperatures can be easily adjusted between 33°F and 38°F using the digital display mounted on the exterior. For seamless service access, cooling components are self-contained and can be conveniently slid out from the side when needed.



Features

- Foamed-in-place insulation
- High weight bearing rails
- Recessed door handle
- Digital temperature controls with LED display
- Removable door gaskets
- 3" casters with locks on front
- 2-year parts and labour warranty
- 5-year compressor warranty

Technical Specifications

- Stainless steel exterior finish
- Stainless steel interior finish
- 115 V/60 Hz
- R290 refrigerant
- Automatic defrost

GCB-36

36" Refrigerated Chef Base

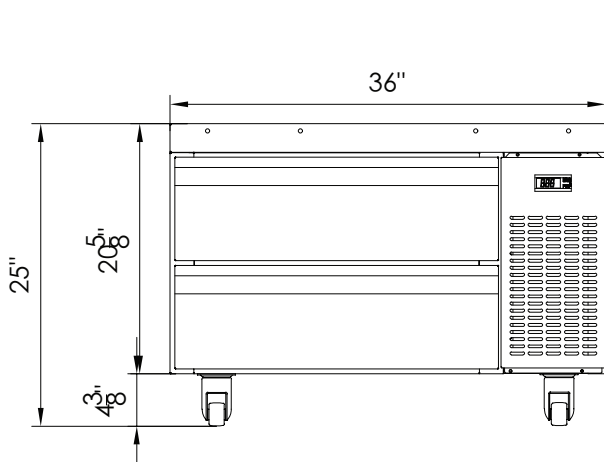

FRONT

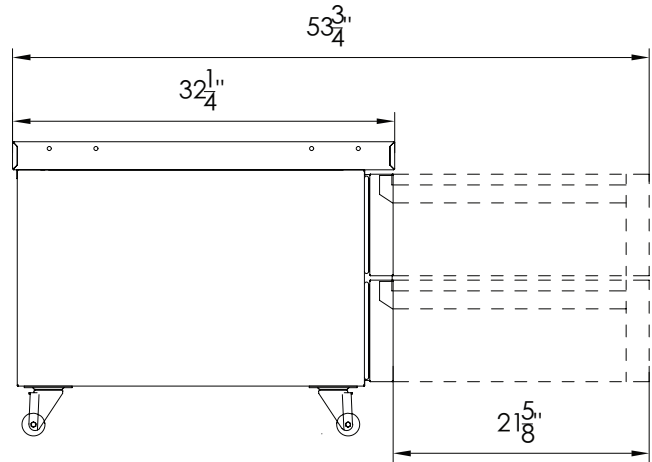

LEFT

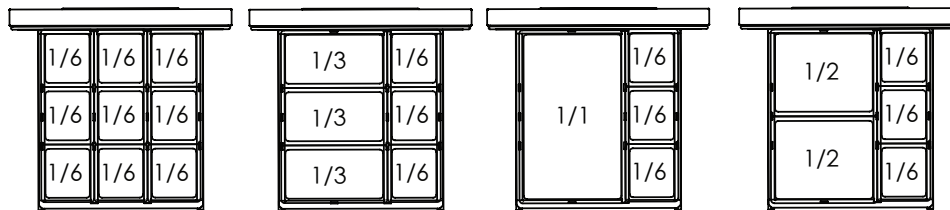

Pans not included

Model	External Dimensions (inches)			Crated Dimensions (inches)			Drawers	Compressor Power (HP)	Net Weight	Gross Weight	1/6 Pan Count	Amps
	W	D	H	W	D	H						
GCB-36	36	32 1/4	25	37 5/8	34 1/4	26 5/8	2	1/5	176	204	2 x 9	1.7

Specifications are subject to change without notice.