

GDC-72SQ

72" Refrigerated Pastry Display Case

The Glacier pastry display case will attract customers with its sleek and modern design that features tempered glass and interior LED lighting. The digital temperature control and automatic defrost system ensures optimal preservation for your products. Built to last with a stainless steel interior and exterior finish, these cases come in a variety of sizes to fit your needs, from 36 to 72 inches wide.



Features

- Tempered glass
- Three tiered shelves
- LED lighting
- Digital temperature controls with LED display
- 2" casters with locks on front
- 2-year parts and labour warranty
- 5-year compressor warranty

Technical Specifications

- Stainless steel exterior finish
- Stainless steel interior finish
- 115 V/60 Hz
- R290 refrigerant
- Automatic defrost

GDC-72SQ

72" Refrigerated Pastry Display Case

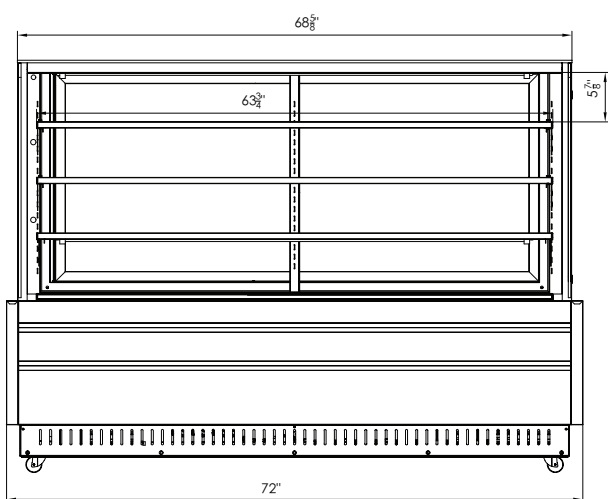

FRONT

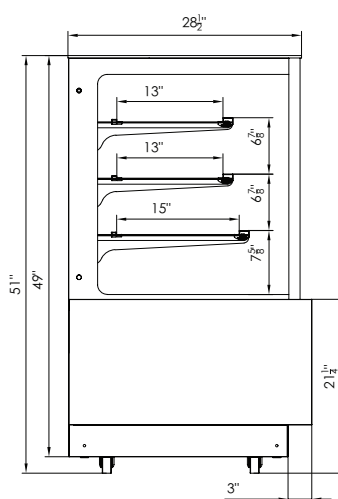

LEFT

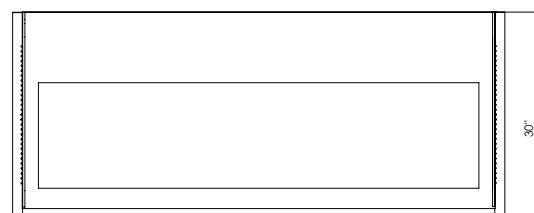

TOP

Model	External Dimensions (inches)			Crated Dimensions (inches)			Temperature Range °F	Compressor Power (HP)	Net Weight	Gross Weight	# of Shelves	NEMA Config.	Amps
	W	D	H	W	D	H							
GDC-72SQ	72	30	51	74 3/4	33 1/2	56 1/4	33 ~ 41°F	4/7	661	749	3	5-15P	8.9

Specifications are subject to change without notice.