

GBB-61G

61" Glass Door Back Bar Cooler

The Glacier back bar refrigerator series offers efficient beverage chilling and organization while maximizing space utilization. The GBB-61G comes with glass hinged doors, locks and 4 adjustable and removable wire shelves as well as bottle rails to customize storage. Featuring precision digital temperature controls, these refrigerators maintain beverages at the optimal serving temperature between 33°F and 38°F. The glass hinged door models are equipped with double pane tempered glass to block UV light and enhance visibility, ensuring beverage quality.



Features

- Tempered hinged glass door
- Door locks
- LED lighting
- Digital temperature controls with LED display
- 4 adjustable and removable wire shelves
- Bottle rails/dividers
- Side mounted compressor
- 2" casters
- 2-year parts and labour warranty
- 5-year compressor warranty

Technical Specifications

- Black exterior finish
- Stainless steel interior finish
- 115 V/60 Hz
- R290 refrigerant
- Automatic defrost

GBB-61G

61" Glass Door Back Bar Cooler

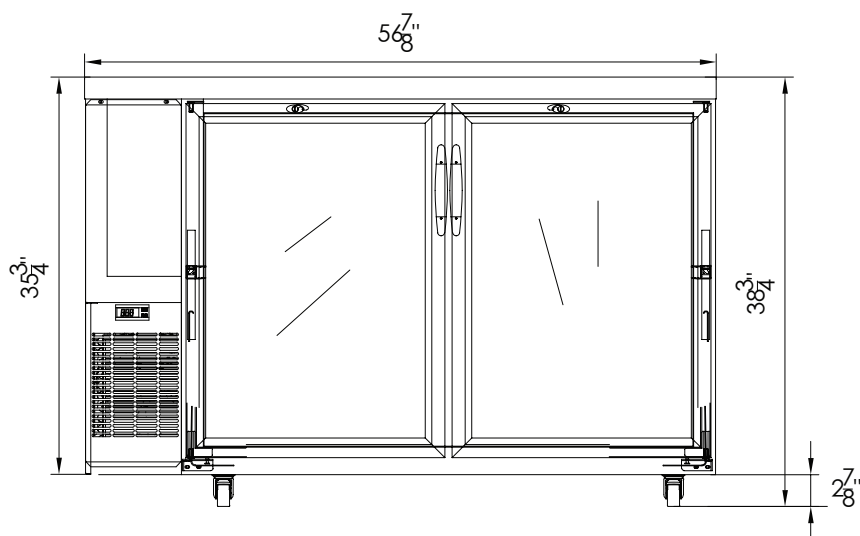

FRONT

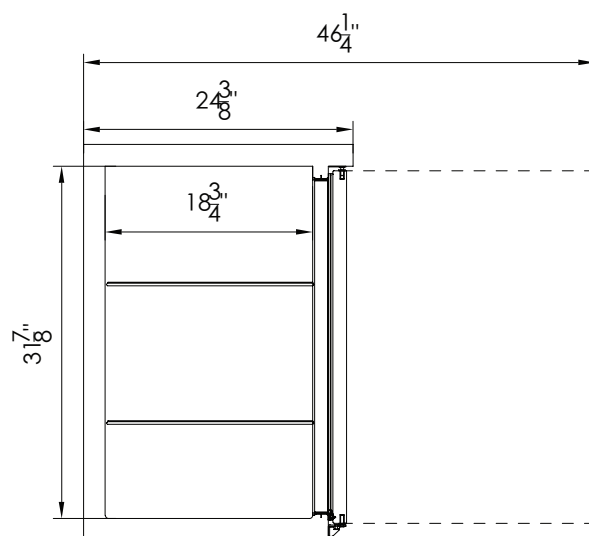

LEFT

Model	External Dimensions (inches)			Crated Dimensions (inches)			Temperature Range °F	Compressor Power (HP)	Net Weight	Gross Weight	# of Shelves	NEMA Config.	Amps
	W	D	H	W	D	H							
GBB-61G	56 7/8	24 3/8	38 3/4	58 4/8	26	42 1/8	33 ~ 41°F	1/3	220	268	4	5-15P	3.5

Specifications are subject to change without notice.